

## ACCESSORY

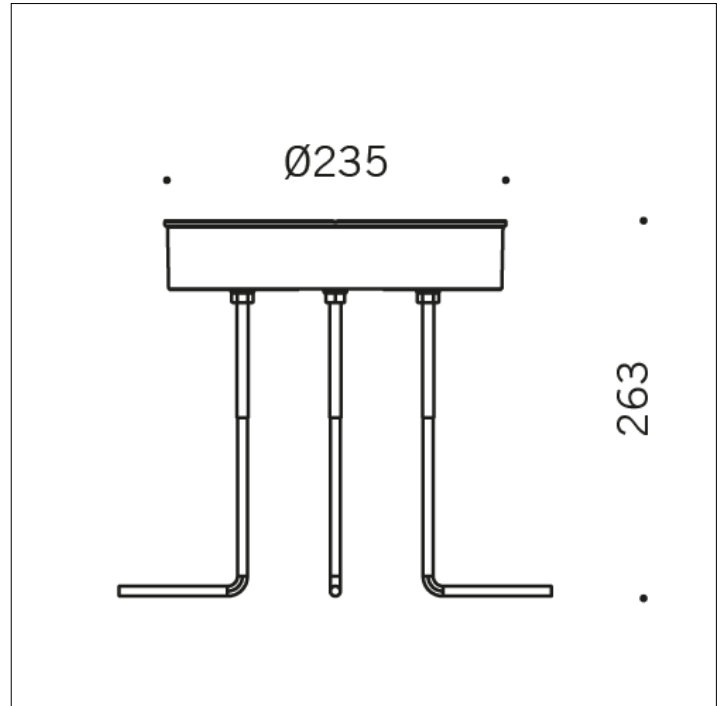

**S.5690**  
**ANCHOR FLANGE TO BE CEMENTED TO THE**  
**GROUND**

For applications in driveways areas, the luminaires must be installed with its proper anchor flange. The flange is provided with the necessary fixing A4 screws in stainless steel.